

AutoCAD on OsX

Part One

Loading Fonts for Counterbore, Countersink & Depth in OsX

Step One: Create some Mtext

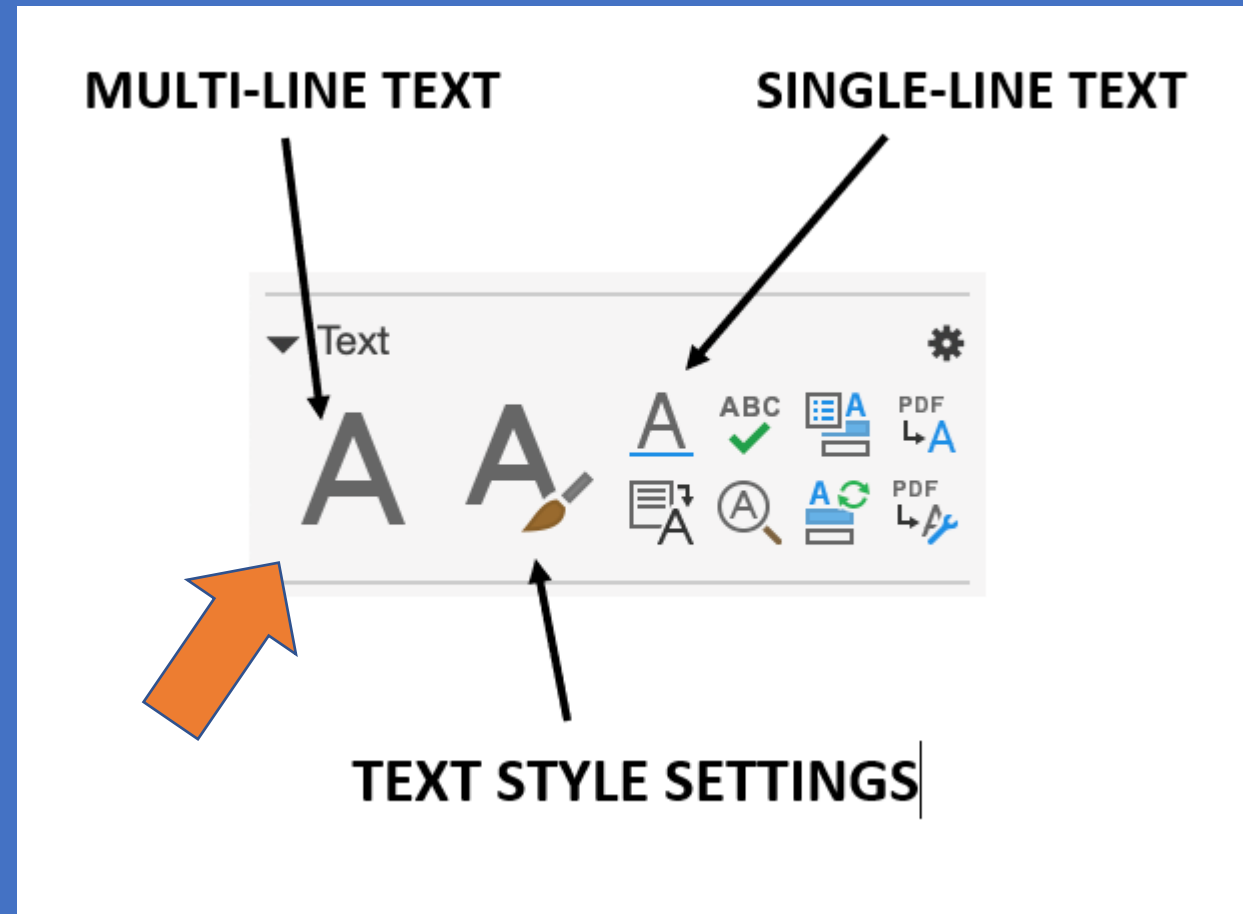

Step Two: Right-click Mtext to get Text Editor

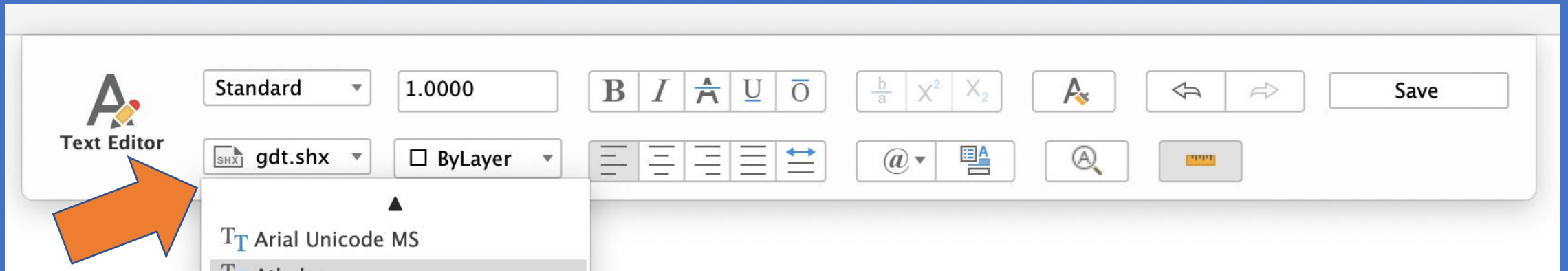

Scroll thru flyout list to gdt.shx

Step Three:

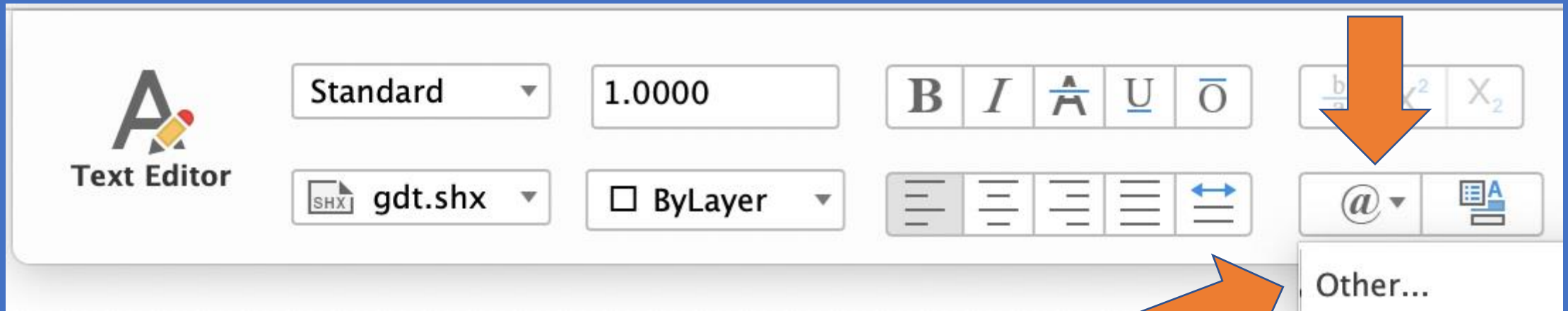

Scroll thru symbol list to Other

Step Four: Click Gear Symbol

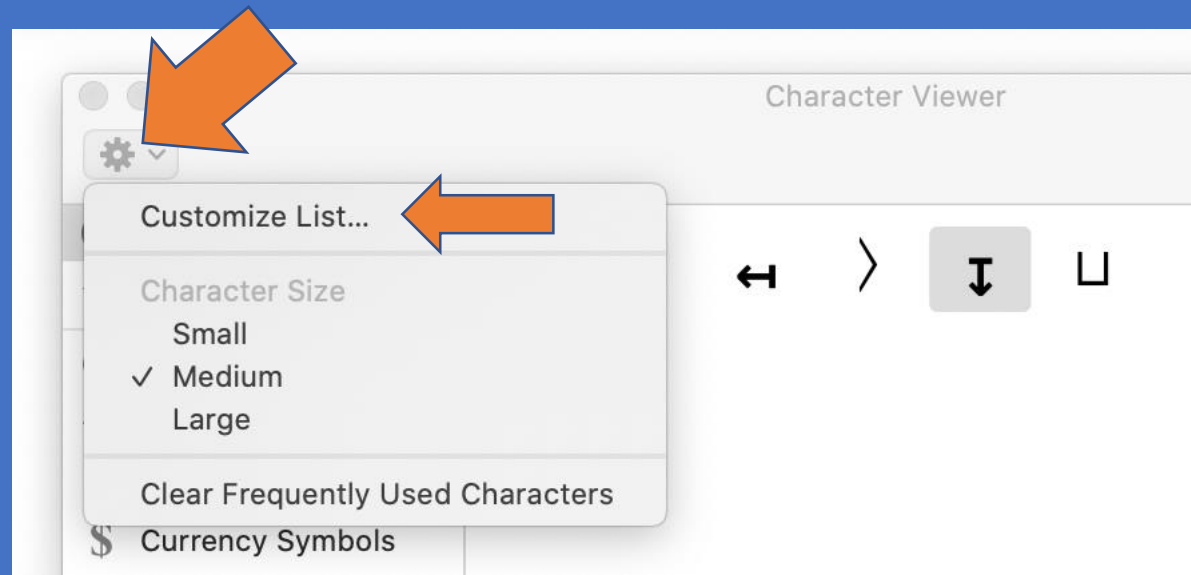

to Customize List

Step Five: from Select Categories Flyout

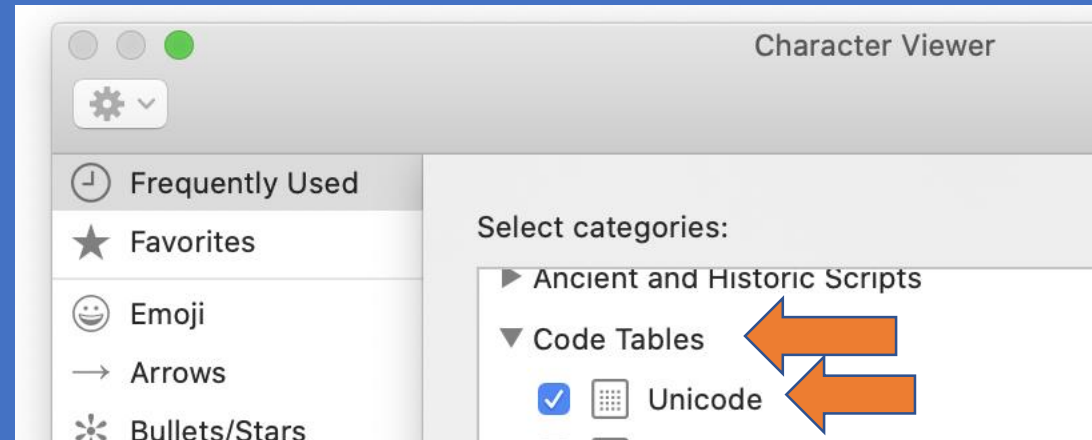

Activate Unicode under Code Tables

Part Two

Adding Symbols to Dimensions

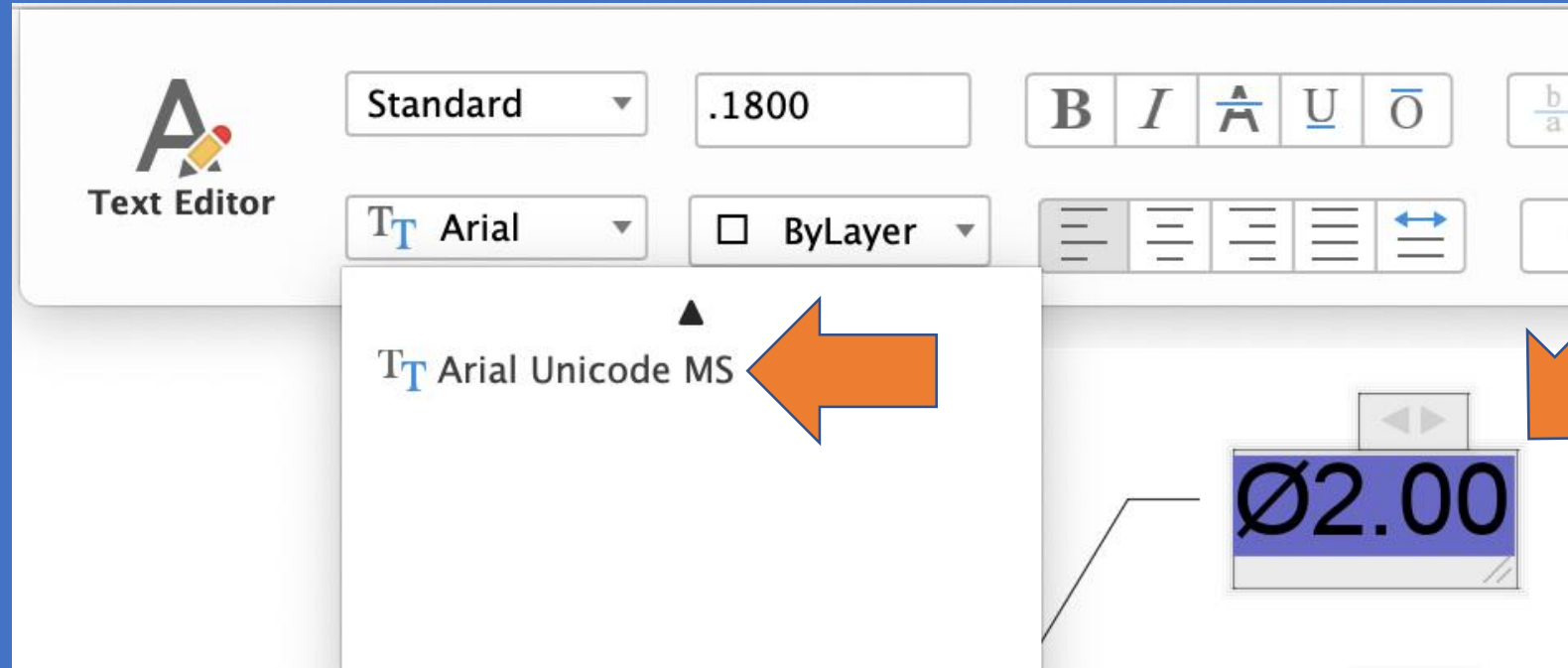

Right-Click Dimension & Change to
Arial Unicode MS

Within Character Viewer

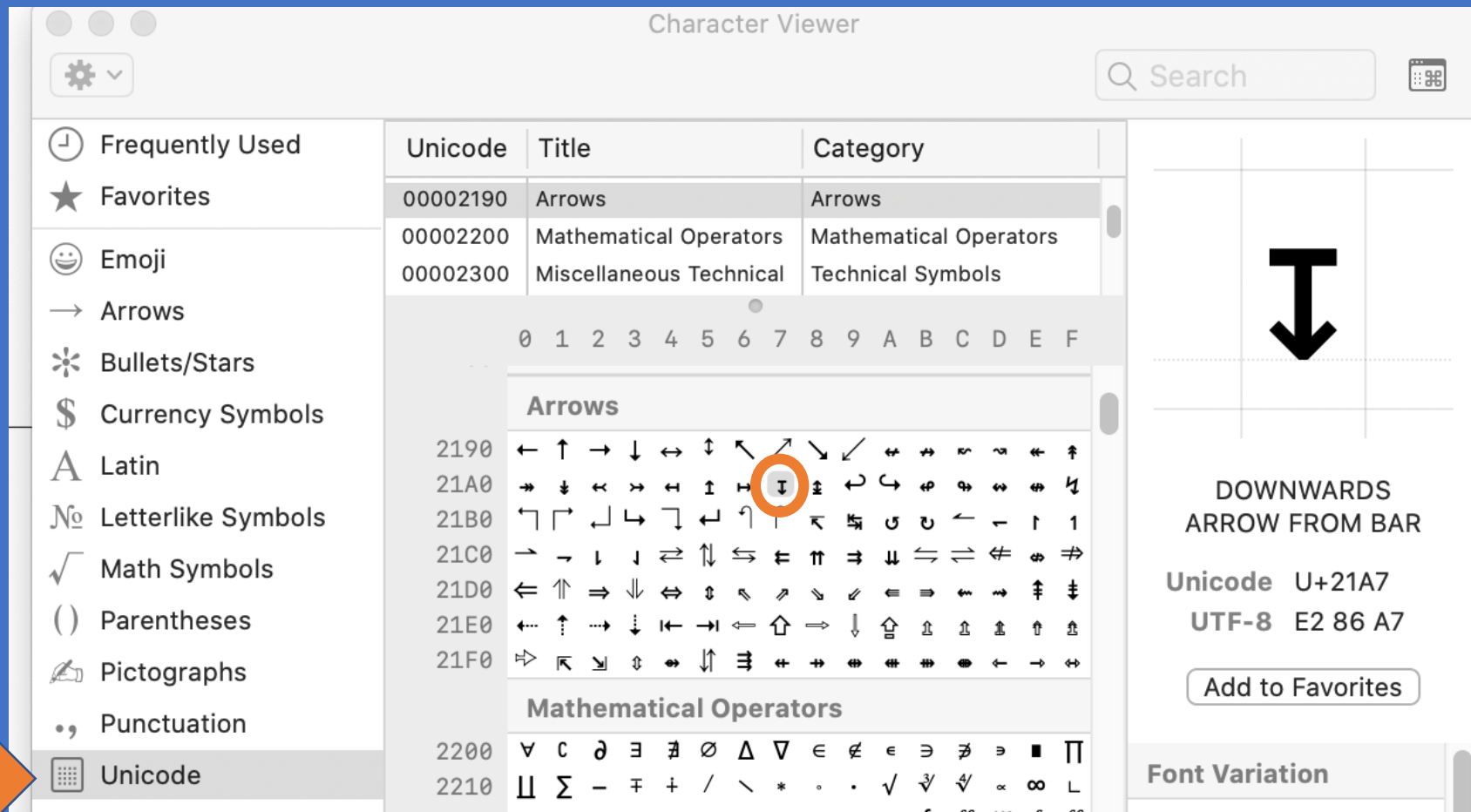

Reverse Highlight Unicode and Select

Unicode Symbols

Depth = 21A7



Counterbore = 2334

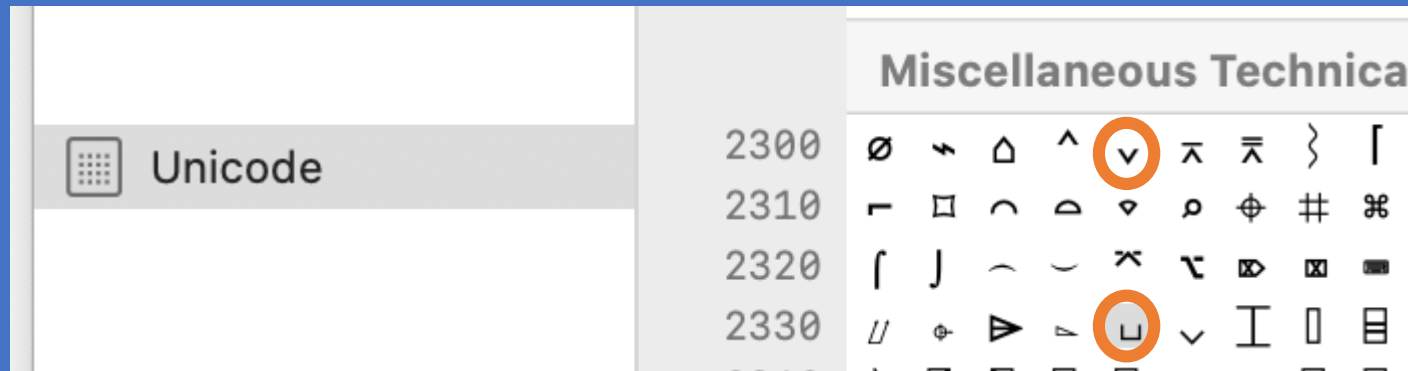

Countersink = 2304

Example with

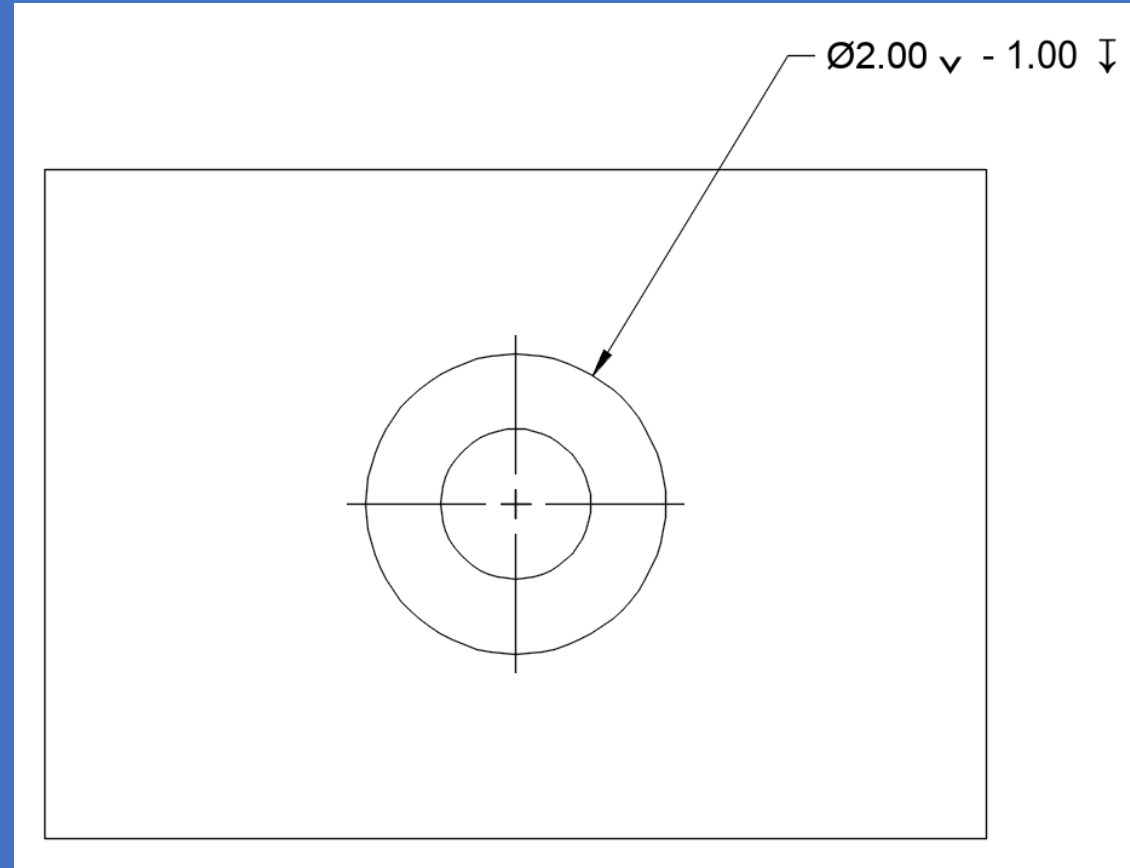

Countersink & Depth Symbols