

FINAL  
DRAFT

INTERNATIONAL  
STANDARD

ISO/FDIS  
15786

ISO/TC 10/SC 6

Secretariat: GOST R

Voting begins on:  
2005-07-04

Voting terminates on:  
2005-09-04

---

---

## Technical drawings — Simplified representation and dimensioning of holes

*Dessins techniques — Représentation et cotation simplifiées des trous*

RECIPIENTS OF THIS DRAFT ARE INVITED TO SUBMIT, WITH THEIR COMMENTS, NOTIFICATION OF ANY RELEVANT PATENT RIGHTS OF WHICH THEY ARE AWARE AND TO PROVIDE SUPPORTING DOCUMENTATION.

IN ADDITION TO THEIR EVALUATION AS BEING ACCEPTABLE FOR INDUSTRIAL, TECHNOLOGICAL, COMMERCIAL AND USER PURPOSES, DRAFT INTERNATIONAL STANDARDS MAY ON OCCASION HAVE TO BE CONSIDERED IN THE LIGHT OF THEIR POTENTIAL TO BECOME STANDARDS TO WHICH REFERENCE MAY BE MADE IN NATIONAL REGULATIONS.



Reference number  
ISO/FDIS 15786:2005(E)

© ISO 2005

**PDF disclaimer**

This PDF file may contain embedded typefaces. In accordance with Adobe's licensing policy, this file may be printed or viewed but shall not be edited unless the typefaces which are embedded are licensed to and installed on the computer performing the editing. In downloading this file, parties accept therein the responsibility of not infringing Adobe's licensing policy. The ISO Central Secretariat accepts no liability in this area.

Adobe is a trademark of Adobe Systems Incorporated.

Details of the software products used to create this PDF file can be found in the General Info relative to the file; the PDF-creation parameters were optimized for printing. Every care has been taken to ensure that the file is suitable for use by ISO member bodies. In the unlikely event that a problem relating to it is found, please inform the Central Secretariat at the address given below.

**Copyright notice**

This ISO document is a Draft International Standard and is copyright-protected by ISO. Except as permitted under the applicable laws of the user's country, neither this ISO draft nor any extract from it may be reproduced, stored in a retrieval system or transmitted in any form or by any means, electronic, photocopying, recording or otherwise, without prior written permission being secured.

Requests for permission to reproduce should be addressed to either ISO at the address below or ISO's member body in the country of the requester.

ISO copyright office  
Case postale 56 • CH-1211 Geneva 20  
Tel. + 41 22 749 01 11  
Fax + 41 22 749 09 47  
E-mail [copyright@iso.org](mailto:copyright@iso.org)  
Web [www.iso.org](http://www.iso.org)

Reproduction may be subject to royalty payments or a licensing agreement.

Violators may be prosecuted.

# Contents

Page

Foreword.....	iv
Introduction .....	v
1 Scope .....	1
2 Normative references .....	1
3 Terms and definitions.....	2
4 Methods of representation and dimensioning of holes.....	2
4.1 Complete representation and complete dimensioning of holes.....	2
4.2 Complete representation and simplified dimensioning of holes.....	2
4.3 Simplified representation and simplified dimensioning of holes .....	2
5 Structure of dimensioning of holes .....	3
5.1 Structure and sequence of descriptive elements for simplified dimensioning of holes .....	3
5.2 Graphical symbols.....	4
5.3 Number of groups of holes and number of holes in a group.....	6
5.4 Tolerances .....	6
5.5 Hole bottom .....	7
5.6 Countersinks and chamfers .....	7
5.7 Depth dimensions.....	7
5.8 Surface texture .....	9
5.9 Geometrical tolerancing (tolerance of position).....	10
Annex A (informative) Examples for representation and dimensioning of holes, counterbores and internal threads .....	11
Bibliography .....	15

## Foreword

ISO (the International Organization for Standardization) is a worldwide federation of national standards bodies (ISO member bodies). The work of preparing International Standards is normally carried out through ISO technical committees. Each member body interested in a subject for which a technical committee has been established has the right to be represented on that committee. International organizations, governmental and non-governmental, in liaison with ISO, also take part in the work. ISO collaborates closely with the International Electrotechnical Commission (IEC) on all matters of electrotechnical standardization.

International Standards are drafted in accordance with the rules given in the ISO/IEC Directives, Part 2.

The main task of technical committees is to prepare International Standards. Draft International Standards adopted by the technical committees are circulated to the member bodies for voting. Publication as an International Standard requires approval by at least 75 % of the member bodies casting a vote.

Attention is drawn to the possibility that some of the elements of this document may be the subject of patent rights. ISO shall not be held responsible for identifying any or all such patent rights.

ISO 15786 was prepared by Technical Committee ISO/TC 10, *Technical product documentation*, Subcommittee SC 6, *Mechanical engineering documentation*.

## Introduction

This International Standard has been established to specify the simplified representation and dimensioning of holes.

The rules established by this International Standard determine, unambiguously, methods for the representation — both complete and simplified — and the dimensioning of holes, as well as the structure and sequence of the descriptive elements for the simplified representation of holes.



# Technical drawings — Simplified representation and dimensioning of holes

## 1 Scope

This International Standard specifies rules on the simplified representation, dimensioning and tolerancing of holes, counterbores, internal threads and chamfers in drawings.

Where there could be misinterpretation using simplified representation, the complete representation and dimensioning by cuts, sections or elements on a larger scale apply, according to ISO 128-30, ISO 128-34, ISO 128-40, ISO 128-44, ISO 128-50, ISO 129-1 and ISO 406.

## 2 Normative references

The following referenced documents are indispensable for the application of this document. For dated references, only the edition cited applies. For undated references, the latest edition of the referenced document (including any amendments) applies.

ISO 128-20:1996, *Technical drawings — General principles of presentation — Part 20: Basic conventions for lines*

ISO 128-22, *Technical drawings — General principles of presentation — Part 22: Basic conventions and applications for leader lines and reference lines*

ISO 128-30, *Technical drawings — General principles of presentation — Part 30: Basic conventions for views*

ISO 128-34, *Technical drawings — General principles of presentation — Part 34: Views on mechanical engineering drawings*

ISO 128-40, *Technical drawings — General principles of presentation — Part 40: Basic conventions for cuts and sections*

ISO 128-44, *Technical drawings — General principles of presentation — Part 44: Sections on mechanical engineering drawings*

ISO 128-50, *Technical drawings — General principles of presentation — Part 50: Basic conventions for representing areas on cuts and sections*

ISO 129-1, *Technical drawings — Indication of dimensions and tolerances — Part 1: General principles*

ISO 406, *Technical drawings — Tolerancing of linear and angular dimensions*

ISO 1101, *Geometrical Product Specifications (GPS) — Geometrical tolerancing — Tolerances of form, orientation, location and run-out*

ISO 1302, *Geometrical Product Specifications (GPS) — Indication of surface texture in technical product documentation*

ISO 5458, *Geometrical Product Specifications (GPS) — Geometrical tolerancing — Positional tolerancing*

ISO 6410-3:1993, *Technical drawings — Screw threads and threaded parts — Part 3: Simplified representation*

### 3 Terms and definitions

For the purposes of this document, the following terms and definitions apply.

**3.1 complete representation of holes**  
representation of holes in accordance with generally valid rules and projection methods for technical drawings

**3.2 simplified representation of holes**  
representation of holes, drawn either true to scale or not, with a symbolic representation of the features

**3.3 complete dimensioning of holes**  
dimensioning of holes using dimension lines and extension lines

**3.4 simplified dimensioning of holes**  
dimensioning of holes using leader lines and reference lines

### 4 Methods of representation and dimensioning of holes

#### 4.1 Complete representation and complete dimensioning of holes

The complete representation and dimensioning of holes according to ISO 128-30, ISO 128-34, ISO 128-40, ISO 128-44, ISO 128-50 and ISO 129-1 applies in all cases where a simplified representation of holes and dimensioning could lead to misinterpretation of the drawing.

#### 4.2 Complete representation and simplified dimensioning of holes

Representation and dimensioning of holes in the profile view is preferred. For dimensioning of the profile, the leader line is directed towards the centre of the hole, ending with an arrowhead on the centre of the hole and an arrowhead on the outline of the hole. For rules relative to the use of leader lines and reference lines, see ISO 128-22.

#### 4.3 Simplified representation and simplified dimensioning of holes

For simplified representation of the side view/section, only the centre lines of the holes are shown. In the case of the profile view, the location of the centre of the hole is represented by a cross using continuous wide lines (according to ISO 128-20:1996, type 01). The location of holes represented parallel to the plane of projection is shown by a continuous narrow line (according to ISO 128-20:1996, type 01).

In the case of simplified dimensioning, the leader line ends with an arrowhead at the centre of the hole or at the point of intersection of the visible edge of the part and the centre line of the hole. The arrowhead points to the surface of the part from which the features are indicated (direction of manufacture; exception, see 5.3) (see Table 1).

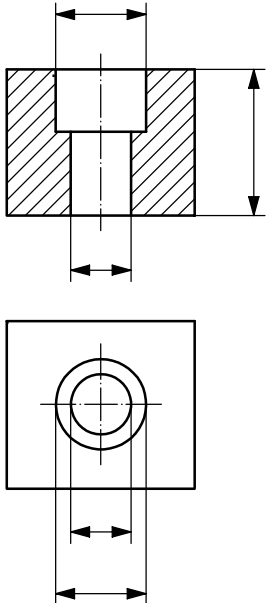
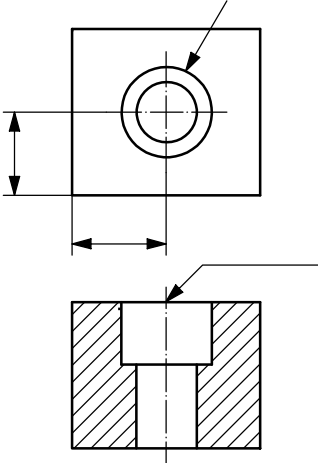
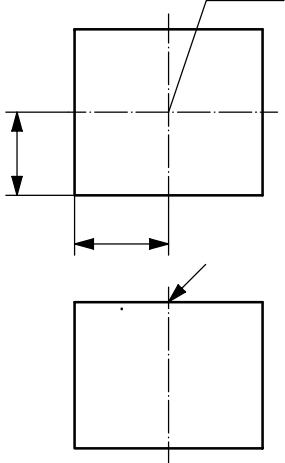

Table 1 — Comparison of methods for representation and dimensioning of holes

Complete representation and complete dimensioning according to ISO 129-1	Complete representation and simplified dimensioning	Simplified representation and simplified dimensioning
		

## 5 Structure of dimensioning of holes

### 5.1 Structure and sequence of descriptive elements for simplified dimensioning of holes

The structure of the simplified dimensioning of holes is composed of continuous enumeration and denominations of features used.

This means that the graphical symbols (e.g.  $\varnothing$ ) and the dimensions (e.g. diameter, hole depths, tolerances) are shown one below the other. The feature with the largest profile shall be shown in the first line.

The data shall be marked in characters of the the same size, with the exception of the indication of surface texture (see 5.9)

The necessary data for each feature, several identical features or several groups of identical features are indicated on one line of the simplified dimensioning.

Structure and sequence of data is explained in Figure 1.

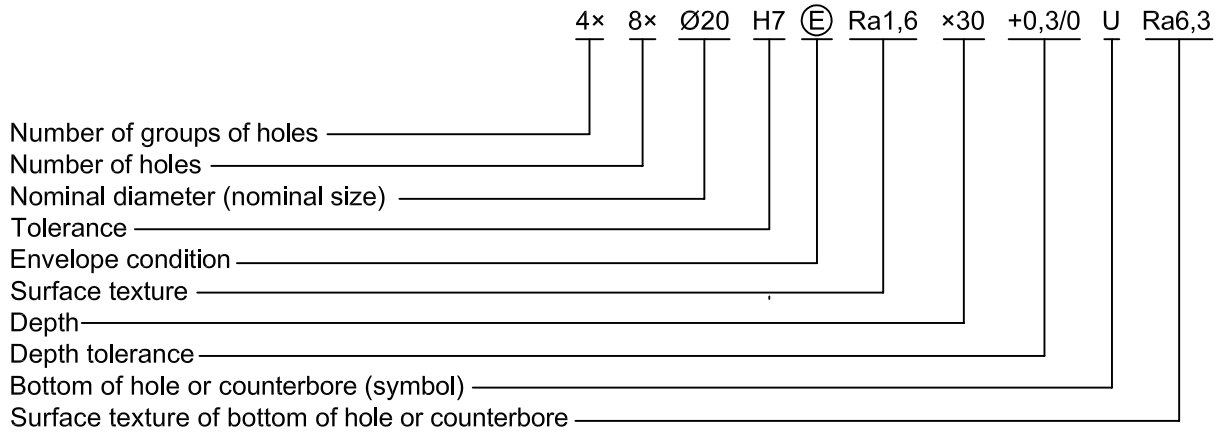

Figure 1 — Structure and sequence of descriptive elements

5.2 Graphical symbols

See Table 2.

Table 2 — Symbols

No.	Symbol	Term	Example	Figure
1	∅	Diameter (ISO 129-1)	∅10	3, 4, 5, 6, 7
2	□	Square (ISO 129-1)	□20	Table A.1, no. 7
3	×	Sign between nominal size and depth or angle dimensions, number of features and of groups of features	M10×25	3, 4, 6, 7, 13
4	/	Sign between depth dimensions or between number of groups and number of features, e.g. thread length and bottom hole depth	M10×25/30	8,11
5	U	Cylindrical counterbore, flat hole bottom	∅10×25U	2, 3
6	V	Material-dependent bit (point angle of hole bottom)	∅10×25V	5
7	W	Indexable insert bit (hole bottom)	∅10×25W	4
8	<u>V</u>	Dimension indicated up to bit	∅10×28 <u>V</u>	7

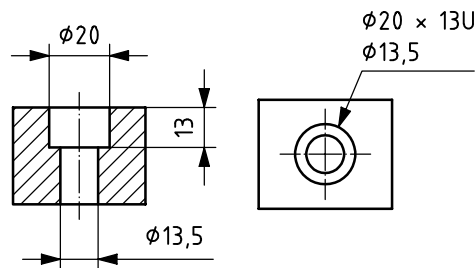

Figure 2 — Complete and simplified representation of hole with counterbore

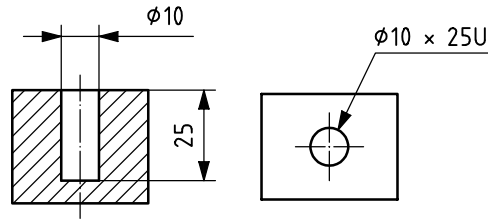

Figure 3 — Complete and simplified representation of hole with flat hole bottom

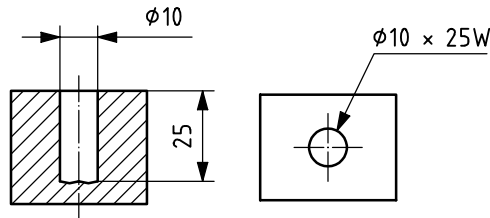

Figure 4 — Complete and simplified representation of hole with bottom produced using indexable insert

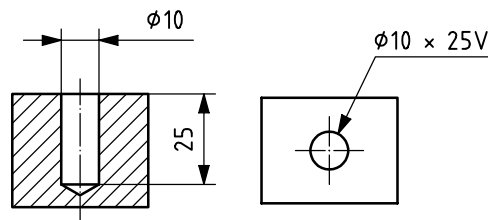

Figure 5 — Complete and simplified representation of hole with dimension to point angle of hole bottom

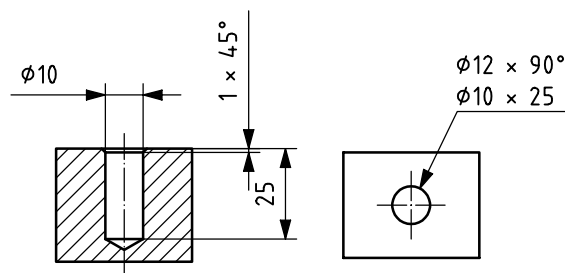

Figure 6 — Complete and simplified representation of chamfered hole (hole bottom not specified)

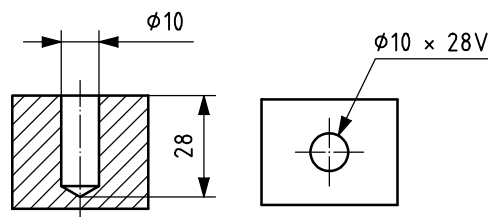

Figure 7 — Complete and simplified representation of hole with dimension indicated up to bit

### 5.3 Number of groups of holes and number of holes in a group

Groups of identical holes (counterbores and bores) shall be dimensioned and toleranced with a single instruction. For the repeated groups of holes, only those dimensions necessary to identify their location shall be indicated. The number of groups of holes and number of holes in each group shall precede the largest diameter of profile.

The number of groups of holes in a group shall precede, and be separated from, the data by the sign “x”, e.g. 5xØ 10 or 6xM10.

The number of holes in a group shall precede and be separated from the number of holes in each group by the sign “x” and a slash “/”, e.g. 3x/5xØ10 or 4x/6xM10 (see Figure 8).

Where ambiguity could occur, group and element description in words may be used, e.g. 3 groups/5 holes Ø10 or 4 groups/6 threads M10. Text descriptions shall not be used in drawings subject to automated data transfer.

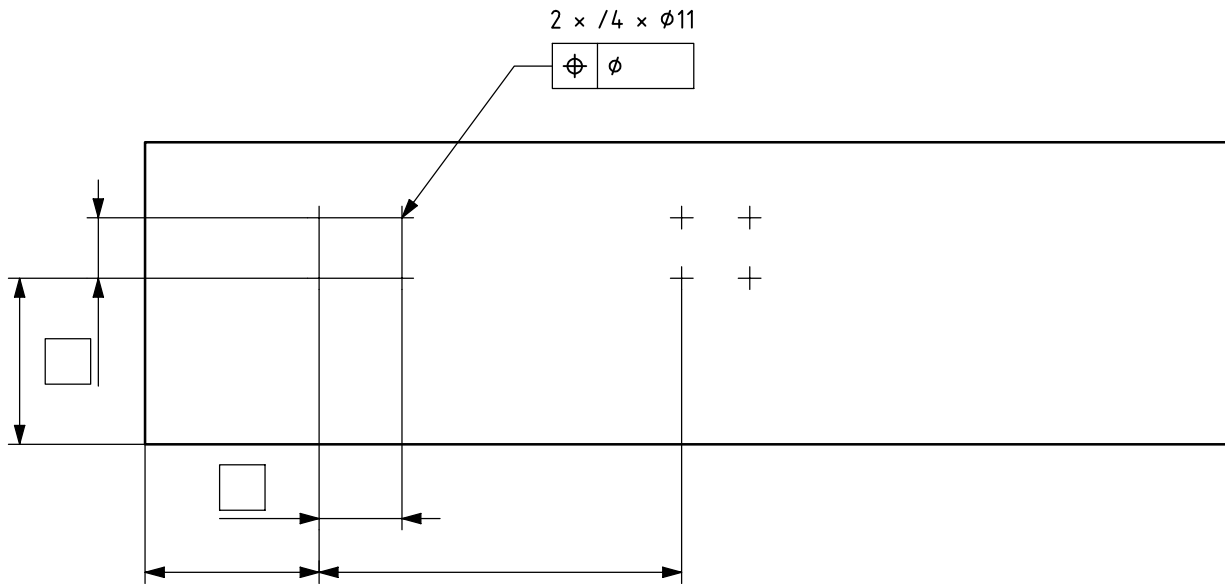

Figure 8 — Simplified representation of two groups with four holes in each group

### 5.4 Tolerances

The indicated dimensions shall be toleranced, either by directly related tolerances or by general tolerances, for example, by ISO 2768-1. See Figures 9 and 10.

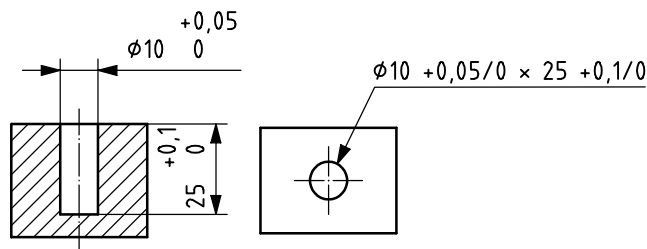

Figure 9 — Complete and simplified representation of a hole with tolerance indication (hole bottom not specified)

## 5.5 Hole bottom

The form of the hole bottom is represented by the graphic symbols “V”, “U” or “W” (see Table 2). If indications on the form of the hole bottom are not available, the form may be at the discretion of the manufacturer.

## 5.6 Countersinks and chamfers

In the case of simplified dimensioning, chamfers and countersinks shall be treated in the same way. The dimensions are shown by indicating the largest diameter and the countersinking angle separated by the sign “x” (see Figure 10).

General tolerances: ISO 2768-m

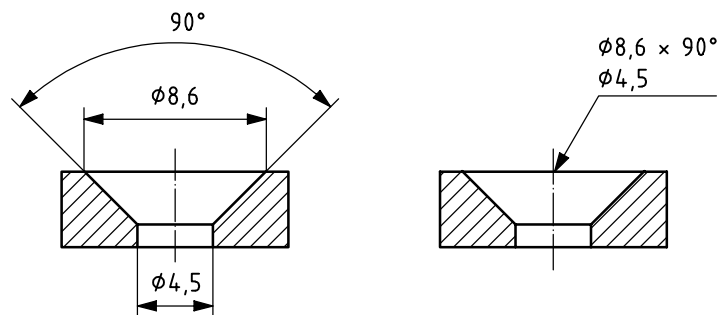

Figure 10 — Complete and simplified representation of chamfer

## 5.7 Depth dimensions

The depth of hole and threads is indicated by the sign “x” as a division sign (see ISO 6410-3).

In the case of thread indications, the threaded length is separated from the cored hole depth by a slash “/” e.g. M10x25/30 (see Figure 11). Holes without depth indications are bored through.

If, in addition to the thread indications, the cored hole diameter is required, this is shown as second feature (see Figure 12). If no indications are made on the cored hole depth for threads, the cored hole is bored through (see Figure 13). In the case of tolerance holes, e.g.  $\varnothing 8H7$ , see Table A.1, no. 3, the depth indication is separated by a slash “/” as well.

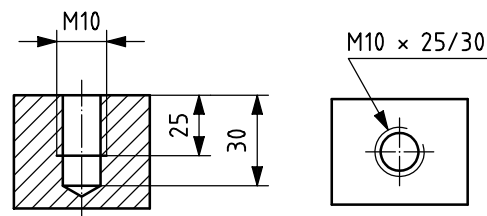

Figure 11 — Complete and simplified representation of a threaded hole with indication of thread length and cored hole depth (hole bottom not specified)

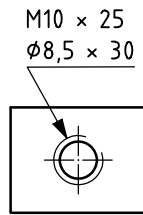

Figure 12 — Simplified representation of a threaded hole with indication of cored hole diameter (hole bottom not specified)

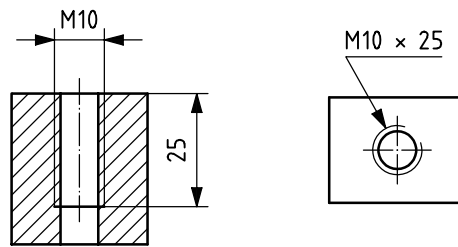
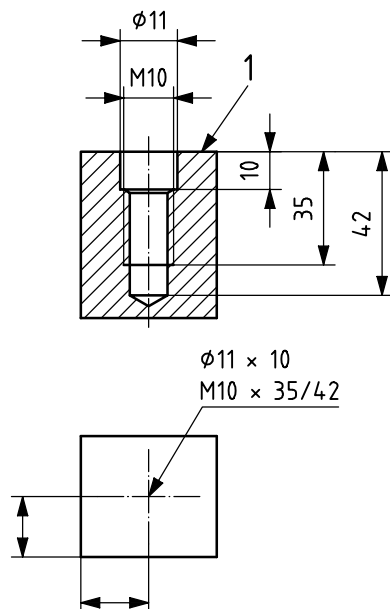

Figure 13 — Complete and simplified representation of a threaded hole with indication of thread length, core hole bored through

In the case of two or more features on one axis, the hole depths shall be indicated always from the same starting plane (see Figure 14). The starting plane of the entire hole is the plane where the largest feature begins (see Figure 15).



**Key**

1 base plane

Figure 14 — Complete and simplified representation of complex threaded countersunk hole with indication of thread length and cored hole depth (hole bottom not specified)

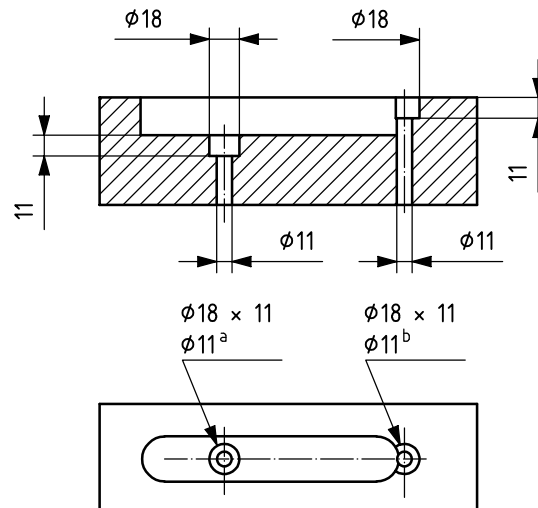

### Key

- 1 base plane 1
- 2 base plane 2
- a Hole 1.
- b Hole 2.

**Figure 15 — Complete and simplified representation of two threaded holes with counterbore and different hole depths**

## 5.8 Surface texture

In order to be able to identify the surface texture conditions, it is necessary, according to ISO 1302 (see Figures 16 and 17), to indicate the corresponding roughness values, even for code designations.

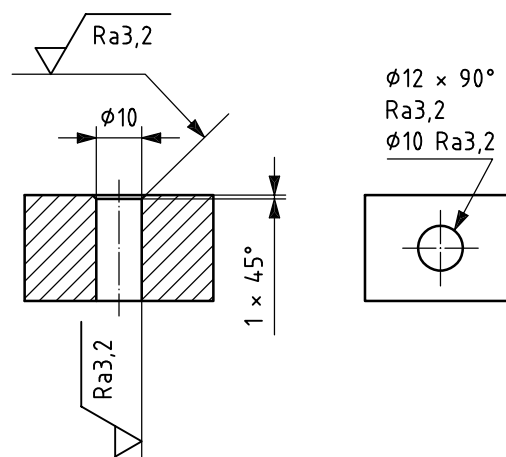

**Figure 16 — Complete and simplified representation of chamfered hole with surface roughness indication**

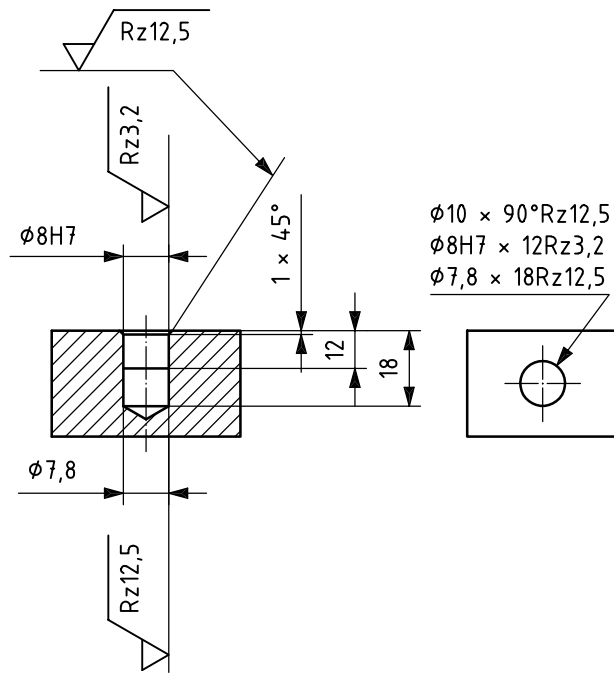

Figure 17 — Complete and simplified representation of complex chamfered hole with surface roughness indications (hole bottom not specified)

### 5.9 Geometrical tolerancing (tolerance of position)

For the indication of geometrical tolerances in accordance with ISO 1101 and ISO 5458, the hole data shall be shown above the tolerance frame (see Figure 18).

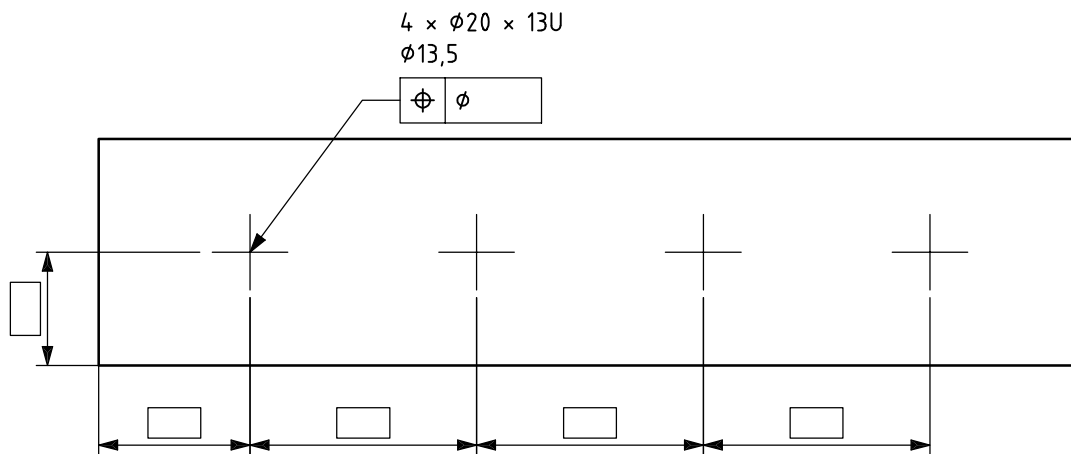

Figure 18 — Simplified representation of group of four holes with counterbore using tolerance frame



## Annex A (informative)

### Examples for representation and dimensioning of holes, counterbores and internal threads

Table A.1 — Examples for representation and dimensioning of holes, counterbores and internal threads

No.	Complete representation and complete dimensioning according to ISO 129-1	Complete representation and simplified dimensioning	Simplified representation and simplified dimensioning	Explanation
1				Through hole $\phi 10$
2				Bottom hole $\phi 10$ , 25 deep (hole bottom not specified)
3				Reamed bottom $\phi 8H7$ , 12 deep bore depth 18, with chamfer $1 \times 45^\circ$
4				Reamed hole $\phi 10H7$ passing through with chamfer $1 \times 45^\circ$
5				Bottom hole $\phi 10$ , 25 deep with flat hole bottom

Table A.1 (continued)

No.	Complete representation and complete dimensioning according to ISO 129-1	Complete representation and simplified dimensioning	Simplified representation and simplified dimensioning	Explanation
6				<p>Square through hole 20×20</p>
7				<p>Through thread M10</p>
8				<p>Thread M10 with threaded length 25, cored hole depth 30</p>
9				<p>Thread M10 with free counterbore Ø11, 10 depth, threaded depth 35 and cored hole depth 42 (measured from base plane)</p>

Table A.1 (continued)

No.	Complete representation and complete dimensioning according to ISO 129-1	Complete representation and simplified dimensioning	Simplified representation and simplified dimensioning	Explanation
10				<p>Left-hand thread M10 with threaded length 25, cored hole bored through</p>
11				<p>Thread M10 with 20° countersink up to cored hole diameter, threaded length 25 and cored hole depth 30</p>
12				<p>Fine taphole M14x1,5 with depth of thread 15 and cored hole diameter 12,5, cored hole depth 30 with flat hole bottom</p>
13				<p>Through hole φ11 with flat counterbore φ22, counterbore depth 3</p>

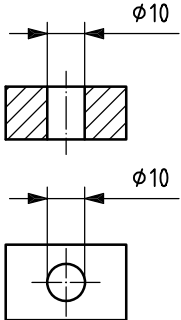
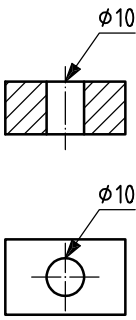
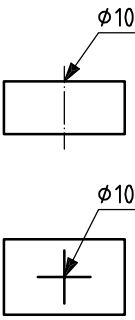
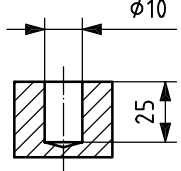
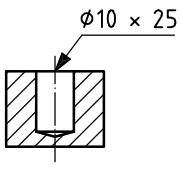
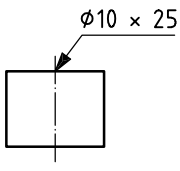
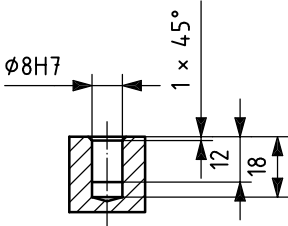
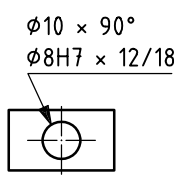
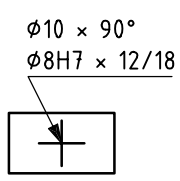
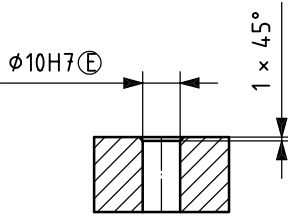
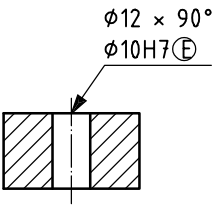
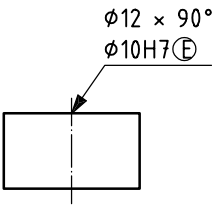
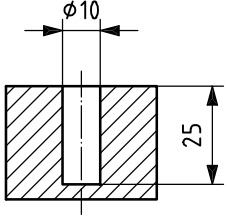
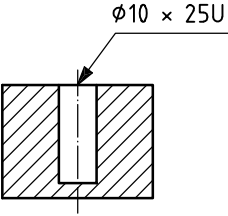
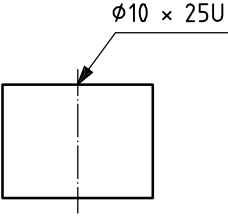
Table A.1 (continued)

No.	Complete representation and complete dimensioning according to ISO 129-1	Complete representation and simplified dimensioning	Simplified representation and simplified dimensioning	Explanation
14				<p>Counterbore for hexagon M10, counterbore diameter <math>\varnothing 18</math>, counterbore depth 11, through hole <math>\varnothing 11</math></p>
15				<p>Through hole <math>\varnothing 4,5</math> with countersink of <math>90^\circ</math> and countersink diameter <math>\varnothing 8,6</math></p>
16				<p>Conical countersink of <math>90^\circ</math> and countersink diameter <math>\varnothing 8,6</math></p>
17				<p>Cylindrical counterbore <math>\varnothing 8</math> with counterbore depth 0,3, through hole <math>\varnothing 4,3</math> with conical countersink of <math>90^\circ</math> and countersink diameter <math>\varnothing 8</math></p>

## Bibliography

- [1] ISO 2768-1, *General tolerances — Part 1: Tolerances for linear and angular dimensions without individual tolerance indications*
- [2] ISO 8015:1985, *Technical drawings — Fundamental tolerancing principle*

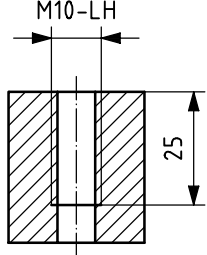
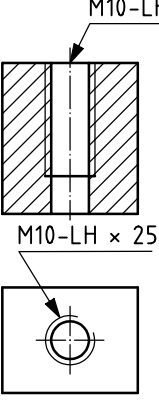
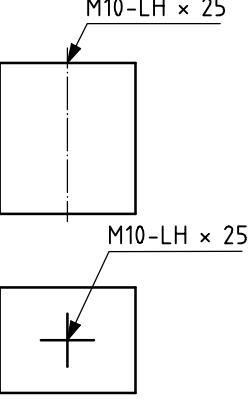
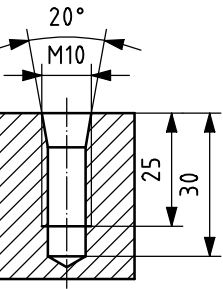
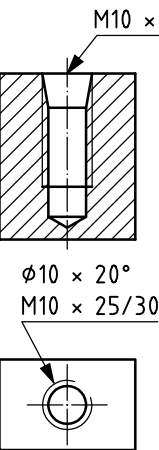
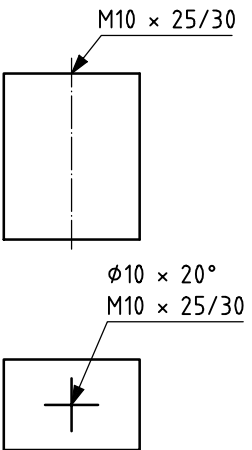
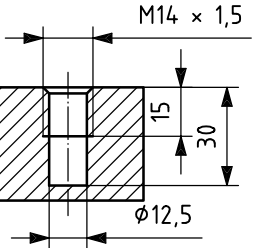
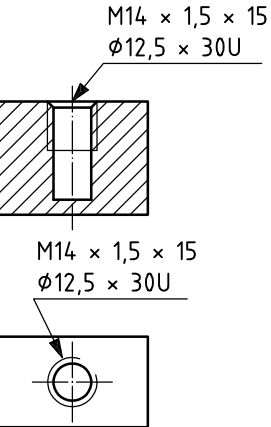
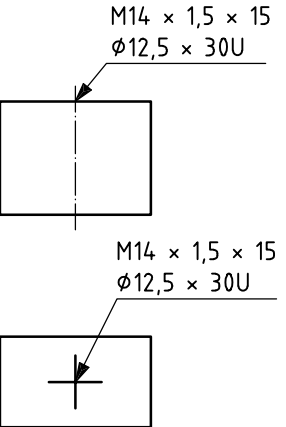
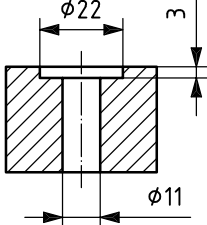
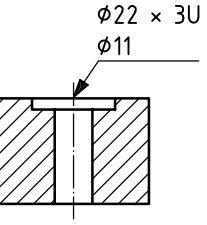
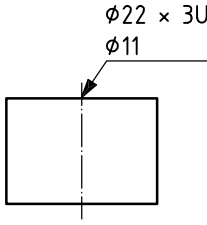